



User's Guide  
**AM/FM Clock Radio**

Manual del Usuario  
**AM/FM Radio Reloj**

Guide d'utilisation  
**Radio-réveil AM/FM**

DCR5500-C



# QUICK REFERENCE

The Quick Reference is given to provide basic operation of the unit. Please completely read the user's guide to take advantage of all the features this unit has to offer.

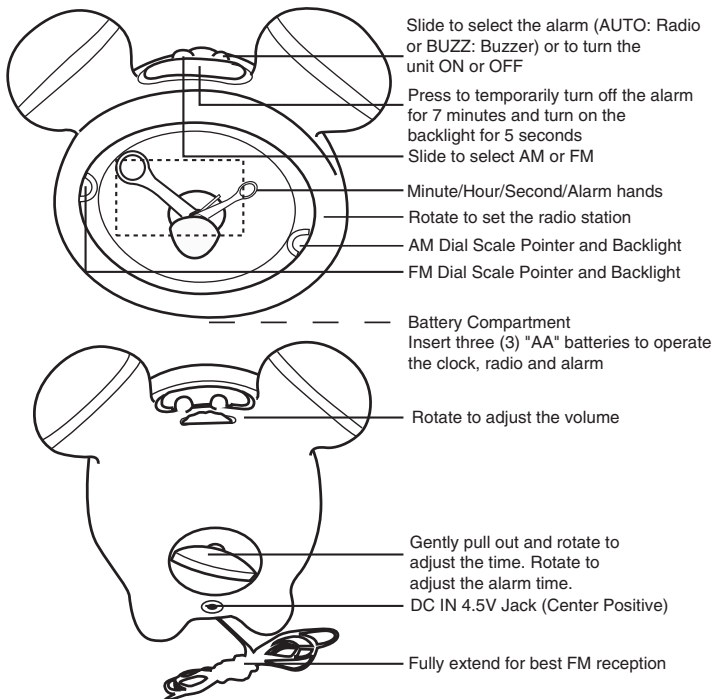

# QUICK REFERENCE (CONTINUED)

## TO LISTEN TO THE RADIO:

1. Slide the AUTO/BUZZ/ON/OFF switch to the ON position to turn the unit on.
2. Slide the Band switch to the desired band, AM or FM.
3. Tune a station by rotating the TUNING ring.
4. Adjust the volume using the Volume control.
5. Slide the AUTO/BUZZ/ON/OFF switch to the OFF position to turn the unit off.

## TO SET OR RESET THE ACTUAL TIME:

Gently pull out and then rotate the Clock/Alarm Time Set knob on the rear of the unit until the current time appears on the front clock.

## TO SET OR RESET THE ALARM TIME:

Rotate the Clock/Alarm Time Set knob on the rear of the unit until the Alarm hand points at the desired alarm hour.

## TO SET THE ALARM TO WAKE TO RADIO:

1. Set the alarm time as instructed above. Select a radio station and make sure the Volume control is set as desired.
2. Slide the AUTO/BUZZ/ON/OFF switch to the AUTO position. When the actual time matches the selected preset alarm time, the radio will automatically turn on.
3. To shut the alarm off, slide the AUTO/BUZZ/ON/OFF switch to the OFF position. Slide the AUTO/BUZZ/ON/OFF switch to the AUTO position to reset it for the next day.

## TO SET THE ALARM TO WAKE TO BUZZER:

1. Set the alarm time as instructed above. Make sure the Volume control is set as desired.
2. Slide the AUTO/BUZZ/ON/OFF switch to the BUZZ position. When the actual time matches the selected preset alarm time, the buzzer will automatically turn on.
3. To shut the alarm off, slide the AUTO/BUZZ/ON/OFF switch to the OFF position. Slide the AUTO/BUZZ/ON/OFF switch to the BUZZ position to reset it for the next day.

## NOTE:

When setting the alarm, please make sure the volume is not at minimum. Otherwise, there will be no sound when alarming.

## BACKLIGHT

Press the SNOOZE button, the backlight will turn on for 5 seconds.

## SNOOZE:

The alarm can be temporarily turned off manually by pressing the SNOOZE button; the alarm will turn back on automatically 7 minutes later.

# SAFETY PRECAUTIONS



## DANGEROUS VOLTAGE:

The lightning flash with arrowhead symbol within an equilateral triangle is intended to alert the user to the presence of uninsulated dangerous voltage within the product's enclosure that may be of sufficient magnitude to constitute a risk of electric shock to persons.



## ATTENTION:

The exclamation point within an equilateral triangle is intended to alert the user to the presence of important operating and maintenance (servicing) instructions in the literature accompanying the appliance.



**CAUTION:** TO REDUCE THE RISK OF ELECTRIC SHOCK, DO NOT REMOVE COVER (OR BACK). NO USER-SERVICEABLE PARTS INSIDE. REFER SERVICING TO QUALIFIED SERVICE PERSONNEL.

- Place the unit on a stable surface.
- Avoid installing the unit in locations described below:
  - Places exposed to direct sunlight or close to heat radiating appliances such as electric heaters.
  - On top of other stereo equipment that radiates too much heat.
  - Places lacking ventilation or dusty places.
  - Places subject to constant vibration.
  - Humid or moist places.

## SURGE PROTECTORS:

It is recommended to use a surge protector for AC connection. Lightning and power surges ARE NOT covered under warranty for this product.

# IMPORTANT SAFETY INSTRUCTIONS

Before using the unit, be sure to read all operating instructions carefully. Please note that these are general precautions and may not pertain to your unit. For example, this unit may not have the capability to be connected to an outdoor antenna.

## 1. READ INSTRUCTIONS

All the safety and operating instructions should be read before the product is operated.

## 2. RETAIN INSTRUCTIONS

The safety and operating instructions should be retained for future reference.

## 3. HEED WARNINGS

All warnings on the product and in the operating instructions should be adhered to.

## 4. FOLLOW INSTRUCTIONS

All operating and use instructions should be followed.

## 5. CLEANING

Unplug this product from the wall outlet before cleaning. Do not use liquid cleaners or aerosol cleaners. Use a dry cloth for cleaning.

## 6. ATTACHMENTS

Do not use attachments not recommended by the product's manufacturer as they may cause hazards.

## 7. WATER AND MOISTURE

Do not use this product near water—for example: near a bathtub, washbowl, kitchen sink or laundry tub; in a wet basement; or near a swimming pool.

## 8. ACCESSORIES

Do not place this product on an unstable cart, stand, tripod, bracket or table. The product may fall, causing serious injury and serious damage to the product. Use only with a cart, stand, tripod, bracket or table recommended by the manufacturer or sold with the product. Any mounting of the product should follow the manufacturer's instructions, and should use a mounting accessory recommended by the manufacturer.

8A. An appliance and cart combination should

be moved with care. Quick stops, excessive force and uneven surfaces may cause the appliance and cart combination to overturn.

PORTABLE CART WARNING  
(symbol provided by RETAC)



## 9. VENTILATION

Slots and openings in the cabinet and in the back or bottom are provided for ventilation, to ensure reliable operation of the product and to protect it from overheating. These openings must not be blocked or covered. The openings should never be blocked by placing the product on a bed, sofa, rug or other similar surface. This product should never be placed near or over a radiator or heat source. This product should not be placed in a built-in installation such as a bookcase or rack unless proper ventilation is provided or the manufacturer's instructions have been adhered to.

## 10. POWER SOURCES

This product should be operated only from the type of power source indicated on the marking label. If you are not sure of the type of power supply to your home, consult your appliance dealer or local power company. For products intended to operate from battery power, or other sources, refer to the operating instructions.

## 11. GROUNDING OR POLARIZATION

This product is equipped with a polarized alternating-current line plug (a plug having one blade wider than the other). This plug will fit into the power outlet only one way. This is a safety feature. If you are unable to insert the plug fully into the outlet, try reversing the plug. If the plug should still fail to fit, contact your electrician to replace your obsolete outlet. Do not defeat the safety purpose of the polarized plug.

## 12. POWER-CORD PROTECTION

Power-supply cords should be routed so that they are not likely to be walked on or pinched by items placed upon or against them, paying particular attention to cords at plugs, convenience receptacles, and the

# IMPORTANT SAFETY INSTRUCTIONS

- point where they exit from the appliance.
13. **LIGHTNING**  
To protect your product from a lightning storm, or when it is left unattended and unused for long periods of time, unplug it from the wall outlet and disconnect the antenna or cable system. This will prevent damage to the product due to lightning and power-line surges.
  14. **POWER LINES**  
An outside antenna system should not be located in the vicinity of overhead power lines or other electric light or power circuits, or where it can fall into such power lines or circuits. When installing an outside antenna system, extreme care should be taken to keep from touching such power lines or circuits as contact with them might be fatal.
  15. **OVERLOADING**  
Do not overload wall outlets and extension cords as this can result in a risk of fire or electric shock.
  16. **OBJECT AND LIQUID ENTRY**  
Never push objects of any kind into this product through openings as they may touch dangerous voltage points or short out parts that could result in fire or electric shock. Never spill or spray any type of liquid on the product.
  17. **SERVICING**  
Do not attempt to service this product yourself as opening or removing covers may expose you to dangerous voltage or other hazards. Refer all servicing to qualified service personnel.
  18. **REPLACEMENT PARTS**  
When replacement parts are required, be sure the service technician uses replacement parts specified by the manufacturer or those that have the same characteristics as the original part. Unauthorized substitutions may result in fire, electric shock or other hazards.
  19. **SAFETY CHECK**  
Upon completion of any service or repairs to this product, ask the service technician to perform safety checks to determine that the product is in proper operating condition.
  20. **WALL OR CEILING MOUNTING**  
The product should be mounted to a wall or ceiling only as recommended by the manufacturer.
  21. **DAMAGE REQUIRING SERVICE**  
Unplug the product from the wall outlet and refer servicing to qualified service personnel under the following conditions:
    - a. When the power-supply cord or plug is damaged.
    - b. If liquid has been spilled or objects have fallen into the product.
    - c. If the product has been exposed to rain or water.
    - d. If the product does not operate normally by following the operating instructions. Adjust only those controls that are covered by the operating instructions, as an adjustment of other controls may result in damage and will often require extensive work by a qualified technician to restore the product to its normal operation.
    - e. If the product has been dropped or the cabinet has been damaged.
    - f. When the product exhibits a distinct change in performance—this indicates a need for service.
  22. **HEAT**  
The product should be situated away from heat sources such as radiators, heat registers, stoves or other products (including amplifiers) that produce heat.
  23. **NOTE TO CATV SYSTEM INSTALLER**  
This reminder is provided to call the CATV system installer's attention to Article 820-40 of the NEC that provides guidelines for proper grounding and, in particular, specifies that the cable ground shall be connected to the grounding system of the building, as close to the point of cable entry as practical.
  24. **NONUSE PERIODS**  
The power cord of the appliance should be unplugged from the outlet when left unused for a long period of time.

# LOCATION OF CONTROLS

## FRONT

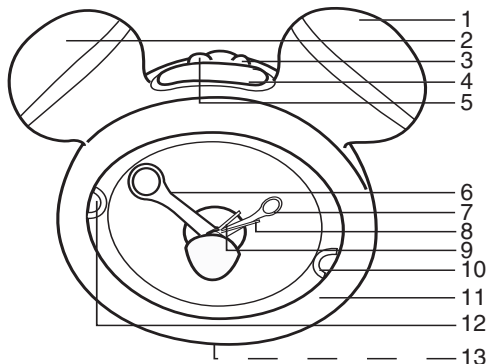

1. Left Speaker
2. Right Speaker
3. AUTO/BUZZ/  
ON/OFF Switch
4. SNOOZE Button
5. Band (FM/AM)  
Switch
6. Minute Hand
7. Hour Hand
8. Second Hand
9. Alarm Hand
10. AM Dial Scale  
Pointer and  
Backlight

## REAR

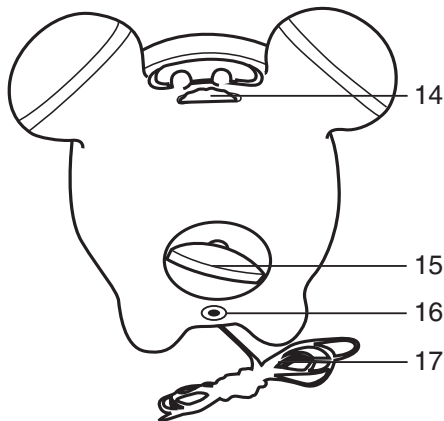

11. TUNING Ring
12. FM Dial Scale  
Pointer and  
Backlight
13. Battery  
Compartment  
(Bottom of Unit)
14. VOLUME Control
15. Clock/Alarm  
Time Set Knob
16. DC IN Jack 4.5V  

17. FM Antenna Wire

# POWER SOURCES

## CLOCK OPERATION

To operate the clock, one (1) AA battery must be installed as follows:

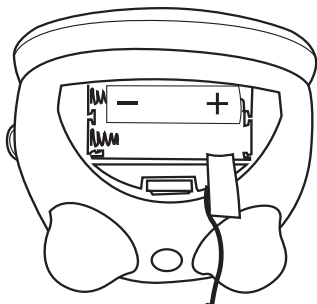
1. Remove the battery compartment door on the bottom of the unit by inserting a small screwdriver, paper clip or similar item into the tab while gently pushing, then lifting it out.
2. Insert one (1) AA battery (not included) as shown at the right and according to the polarity diagram. Alkaline batteries are recommended for longer playing time.



## ALARM AND RADIO OPERATION

The alarm and radio can be powered by either two (2) AA batteries or an AC adapter (not included).

## BATTERY OPERATION

1. Remove the battery compartment door on the bottom of the unit by inserting a small screwdriver, paper clip or similar item into the tab while gently pushing, then lifting it out.
2. Insert two (2) AA batteries (not included) as shown at the right and according to the polarity diagram. First insert the battery labeled "1", and then the battery labeled "2". Alkaline batteries are recommended for longer playing time.

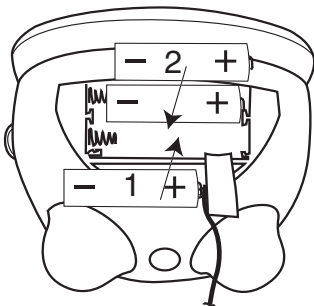



# POWER SOURCES (CONTINUED)

## BATTERY PRECAUTIONS

Follow these precautions when using batteries in this device:

1. Use only the size and type of batteries specified.
2. Be sure to follow the correct polarity when installing the batteries as indicated next to the battery compartment. Reversed batteries may cause damage to the device.
3. Do not mix different types of batteries together (e.g. Alkaline, Rechargeable and Carbon-zinc) or old batteries with fresh ones.
4. If the device is not to be used for a long period of time, remove the batteries to prevent damage or injury from possible battery leakage.
5. Do not try to recharge batteries not intended to be recharged; they can overheat and rupture. (Follow battery manufacturer's directions.)

## AC Operation

To operate the unit using AC power, connect a 4.5V DC, 600mA AC adapter with positive center (included) to the DC jack on the rear of the unit and then to a wall outlet having 120V, 60Hz AC only.

DC 4.5V 

## NOTES:

- The batteries that operate the radio and the alarm are automatically disconnected when the AC adapter is used.
- The AC adapter will NOT operate the time, you must install the battery as described on the previous page.

# OPERATION

## TO LISTEN TO THE RADIO

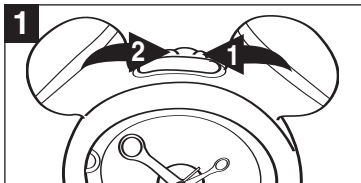

Slide the AUTO/BUZZ/ON/OFF switch ❶ to the ON position to turn the unit on. Slide the Band switch ❷ to the desired band, AM or FM.

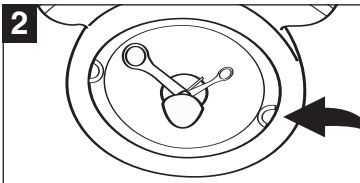

Tune a station by rotating the TUNING ring.

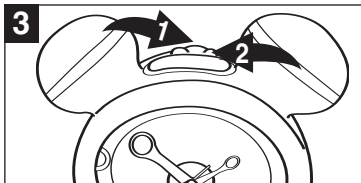

Adjust the volume using the Volume control ❶. Slide the AUTO/BUZZ/ON/OFF switch ❷ to the OFF position to turn the unit off.

### Antennas

FM: Extend the FM antenna wire (located in the battery compartment) for best reception.

AM: Turn the unit for better AM reception.

## BACKLIGHT

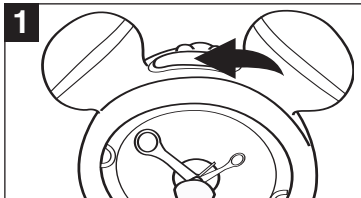

Press the SNOOZE button, the backlight at the AM and FM Dial Scale Pointer will light on for 5 seconds. This is useful for observing the time and the Radio frequency when using the unit at night.

# OPERATION (CONTINUED)

## TO SET OR RESET THE ACTUAL TIME

1

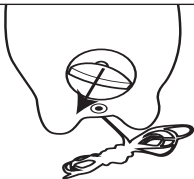

Gently pull out the Clock/Alarm Time Set knob on the rear of the unit.

2

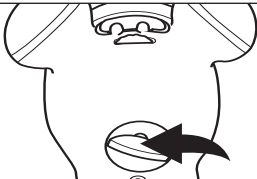

Rotate the Clock/Alarm Time Set knob on the rear of the unit until the current time appears on the front clock. Then gently push in the Clock/Alarm Time Set knob to replace the knob.

## TO SET OR RESET THE ALARM TIME

1

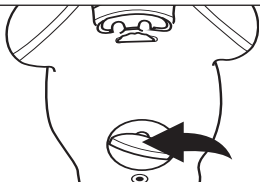

Rotate the Clock/Alarm Time Set knob on the rear of the unit until the Alarm hand points at the desired alarm hour.

# OPERATION (CONTINUED)

## TO SET THE ALARM TO WAKE TO RADIO

1

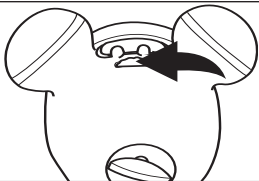

Set the alarm time as previously instructed. Select a radio station as described on page 9 and make sure the Volume control is set as desired.

**NOTE:** Make sure the volume is not at minimum, otherwise, there will be no sound when alarming.

2

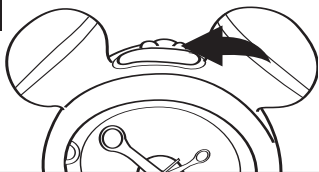

Slide the AUTO/BUZZ/ON/OFF switch to the AUTO position. When the actual time matches the selected preset alarm time, the radio will automatically turn on.

3

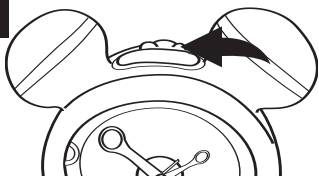

To shut the alarm off, slide the AUTO/BUZZ/ON/OFF switch to the OFF position. Slide the AUTO/BUZZ/ON/OFF switch to the AUTO position to reset it for the next day. See page 13 for the Snooze feature.

# OPERATION (CONTINUED)

## TO SET THE ALARM TO WAKE TO BUZZER

1

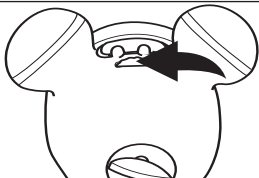

Set the alarm time as previously instructed. Make sure the Volume control is set as desired.

**NOTE:** Make sure the volume is not at minimum, otherwise, there will be no sound when alarming.

2

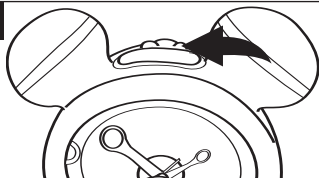

Slide the AUTO/BUZZ/ON/OFF switch to the BUZZ position. When the actual time matches the selected preset alarm time, the disney alarm will automatically turn on.

3

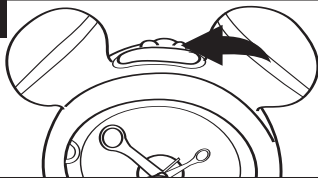

To shut the alarm off, slide the AUTO/BUZZ/ON/OFF switch to the OFF position. Slide the AUTO/BUZZ/ON/OFF switch to the BUZZ position to reset it for the next day. See page 13 for the Snooze feature.

# OPERATION (CONTINUED)

## TO SHUT THE ALARM OFF

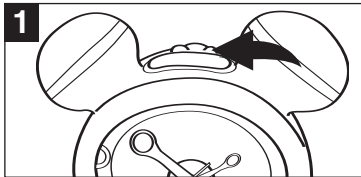

To shut the alarm off, slide the AUTO/BUZZ/ON/OFF switch to the OFF position. Slide the AUTO/BUZZ/ON/OFF switch to the AUTO or BUZZ position to reset it for the next day.

## SNOOZE

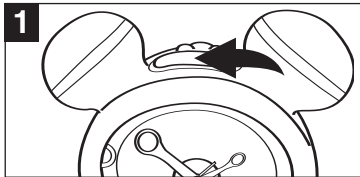

The alarm can be temporarily turned off manually by pressing the SNOOZE button; the alarm will turn back on automatically 7 minutes later.

**NOTE:** When the SNOOZE button is pressed, the AM/FM Dial Scale Pointer and Backlight will light for 5 seconds.

# TROUBLESHOOTING GUIDE

Should this unit exhibit a problem, check the following before seeking service:

<b>SYMPTOM</b>	<b>POSSIBLE CAUSE</b>	<b>POSSIBLE SOLUTION</b>
<b>RADIO/ALARM</b>		
No sound.	AUTO/BUZZ/ON/OFF switch not set to ON.	Set AUTO/BUZZ/ON/OFF switch to ON.
	Volume control at minimum position.	Increase the volume.
Noise or sound distorted on AM or FM.	AM—Interference from traffic.	Turn the radio for better AM reception.
	FM—Antenna Wire not extended.	Extend Antenna Wire.
	Batteries dead or weak.	Replace batteries; see page 7.
	AC adapter not connected properly.	Check connection.
<b>CLOCK</b>		
Clock does not operate.	Battery not inserted.	Insert battery for clock to operate; see page 7.
Alarm does not turn on.	AUTO/BUZZ/ON/OFF switch not set to AUTO or BUZZ.	Set AUTO/BUZZ/ON/OFF switch to the AUTO or BUZZ position as desired.
	Volume is set to minimum.	Make sure the volume is not set to minimum.

For additional set-up or operating assistance, please visit our website at [www.disneyelectronics.com](http://www.disneyelectronics.com) or contact customer service at (954) 660-7026.

Please keep all packaging material for at least 90 days in case you need to return this product to your place of purchase or Memcorp.

For parts and accessories, contact Fox International at 1-800-321-6993.

Distributed by Memcorp Inc., Weston, FL, Disney Elements © Disney 2004.

Para información adicional sobre la configuración o si necesita asistencia con la operación del equipo, por favor visítenos en nuestra página web [www.disneyelectronics.com](http://www.disneyelectronics.com) o si requiere asistencia directa, comuníquese con nuestro departamento de servicio al cliente al número (954) 660-7026.

Por favor mantenga todo el material de empaque por lo menos por 90 días, en caso que usted necesite devolver el producto donde lo compro a directamente a Memcorp Inc.

Para Accesorios o Partes en general, por favor comuníquese con Fox International al número 1-800-321-6993.

Distribuido por Memcorp inc. Weston, FL, Disney Elements@Disney 2004.

Pour obtenir des informations supplémentaires sur l'installation ou une assistance concernant l'emploi de votre produit, veuillez visiter notre site Web sur [www.disneyelectronics.com](http://www.disneyelectronics.com) ou contacter notre service clientèle au (954) 660-7026.

Veillez conserver tout matériel d'emballage pendant au moins 90 jours au cas où vous devriez renvoyer votre produit à votre revendeur ou directement à Memorex.

Pour les pièces et les accessoires, contactez Fox International at au 1-800-321-6993

Distribué par Memcorp. inc . Weston, FL, Disney Elements@Disney 2004.